

**165** Lm/W



# DRAGONFLY

## LED Sports Floodlighting 480W 600W

High performance lighting ideal for sports fields and stadiums. Each module can be adjustable with the marking scale to adjust the angle accurately, which help achieve the perfect uniformity illumination.

---



## ▼ LED FLOOD LIGHTING - AREA FLOOD LIGHTING



Other LED lighting



DRAGONFLY LED lighting  
(modules 360° Rotatable)

## ▼ HIGH POWER LED FLOODLIGHT FOR SPORTS LIGHTING APPLICATIONS

Most manufacturers design the lighting fixtures implementing lens and reflector technologies for desired light distribution. These existing LED lighting methods according to the characteristics of the light will spread to a wider area and will also fall on the area that does not need the light and may lead to light pollution which is inefficient in terms of energy savings. 's DRAGONFLY technology prevents light pollution and emits the light only to the target area, DRAGONFLY is advanced technology to control luminance with low power consumption to provide a similar level of luminous flux and also to maximize energy savings.

- Unique quality of light with flickerfree operation suitable for HDTV broadcasting and Super Slow Motion
- Flexible optical system optimising lighting distributions for best in class results
- Compact and low weight for minimal structural costs
- Fully controllable solution enabling instant lighting, stepped illumination levels and event lighting with dynamic lighting scenarios

# FEATURE

DRAGONFLY LED Sports Floodlighting 480W 600W



## ▼ Light weight

The advantage of aluminum fin heat dissipation is that the weight is reduced by about 30% to 40%. This is an advantage compared to traditional die-cast aluminum lamps for sports field lighting installations. To reduce the loading weight of the pole and to reduce the workload of the installer.

## ▼ Floded fin

This allows you to improve thermal performance while adding a minimal amount of weight. Floded Fin heatsinks use a continuous strip of aluminum sheet metal affixed to an aluminum base plate. The advantage of Floded Fin as opposed to extruded heatsinks is higher aspect ratios and thinner fins, thus increasing surface area and lowering thermal resistance. The stamping riveting process is not welded so that it make the auminum fins fit more closely with the aluminum board, creating more surface touching area from led chips heat to the heat sink and contributing to faster heat dissipation.



## ▼ Surface Treatments

The surface of the heat sink is environmentally friendly and recyclable by powder electrostatic spraying process, which is resistant to corrosion, oxidation and aging.

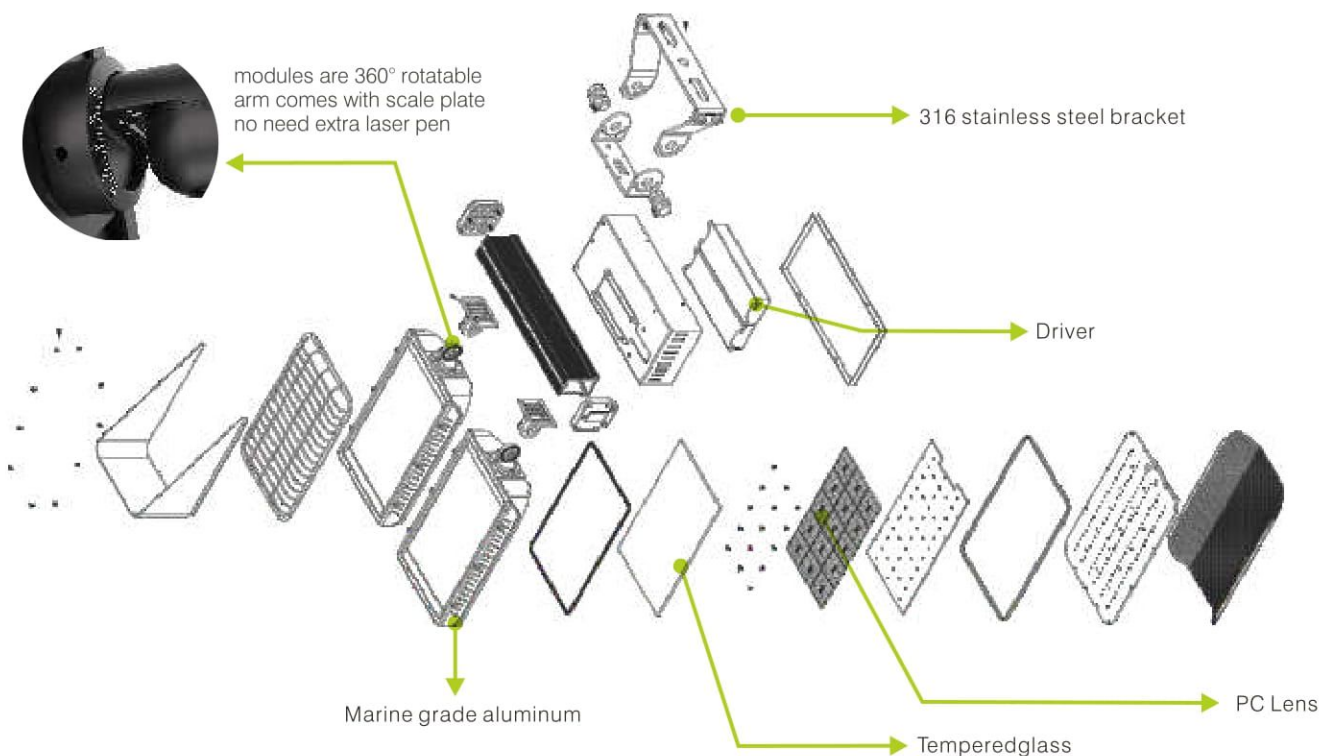

# SPECIFICATION

## DRAGONFLY LED Sports Floodlighting 480W 600W



### Product DRAGONFY LED Sports Floodlight

Model	480W	600W
System Efficacy	165LM/W±3%	155LM/W±3%
Luminous Flux (Photometered)	79,200Lm	93,000Lm
Light Source	Lumileds 5050	
Meanwell ELG Driver	2*XLG-240-H-A	2*ELGC-300-H-A
Distribution Type	10° / 20° / 60° / 90°10°(P50-P8) /135x60°(P50) / 97x47°(TypeV)	
CCT	30K - 3000K 40K - 4000K	50K - 5000K 57K - 5700K
CRI	>70 (Optional with CRI>90)	
Surge protection device	6KV	

### Product DRAGONFY LED Sports Floodlight

Model	480W Typical	600W Typical
Weight/Packaging		
Luminaire Weight	16.2Kg	17Kg
Packaging Dimensions	1pc / 86x68x26cm	
Packaged Weight	18.2Kg	19Kg

### Electrical Characteristics (Luminaire)

Power Consumption	480W Typical	600W Typical
Input Volt	100-277VAC	
Frequency Range	47-63Hz	
Power Factor	>0.95 / 230VAC	
Total Harmonic Distortion	< 20%	
Dimming Function	1 - 10V Continuous / PWM DALI Optional	

### Certificates (Safety Standards)

ETL		✓
DLC(Standard)		✓
ENEC	IEC/EN60598-2-3	✓
CB	IEC/EN60598-1	✓
TUV CE-LVD	IEC/EN62778	✓
Australian deviation		✓
TUV CE-EMC	EN55014 EN61547 EN61000-3-2 EN61000-3-3	✓
SAA		✓
TUV IK08		✓
Salt Spray Test	24H	✓
IP66	By ENEC	✓
Flammability test	By ENEC	✓
Lm79		✓
Lm80		✓

### Environmental

IP Rating	IP66
Impact Rating	Ik08
Salt Spray Tested	Yes
Operating Temp. Range	-30° ~ 122°F (-30° ~ 45°C)
Operating Humidity	15 - 90%
Thermal Management Type	Natural air cooling Floded Aluminium fin
Expected Lifespan	L70B10 50,000hours
Material Composition (Body)	ADC-12 Aluminium + Marine grade aluminium
Material Composition (Optics)	PMMA (UV Resistance)
Material Composition (Cover)	Extra clear tempered glass protect
Mounting/Bracket Type	Post-top position, Side-entry position
Modules Rotatable	360°
Replacement	1200-1500W HPS MH

### Warranty

Warranty	5 years warranty 7 years extended warranty available
----------	---

# DIMENSIONS

## DRAGONFLY LED Sports Floodlighting 480W 600W

**Height:** 25.9 in (685 mm)

**Length:** 21.78 in (553mm)

**Width:** 6.8 in (173 mm)

**Luminaire Weight:** 16.2kg(480W) 17Kg(600W)

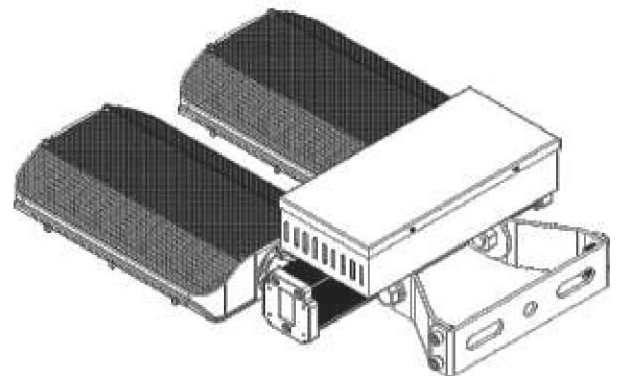
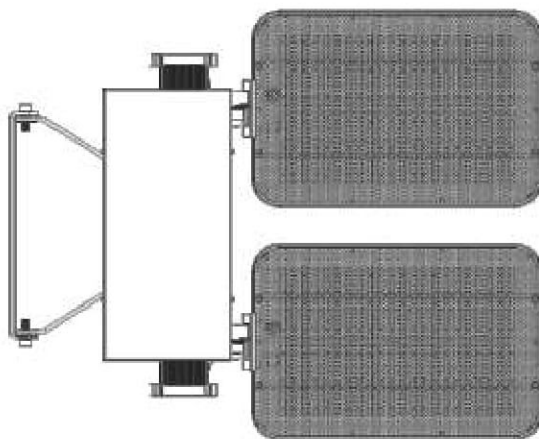
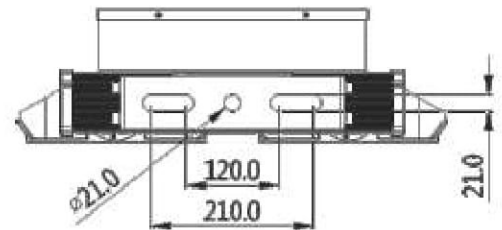
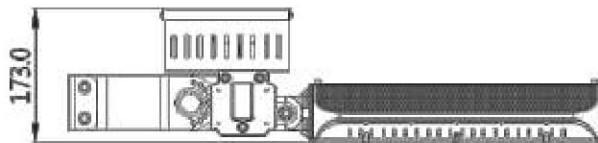
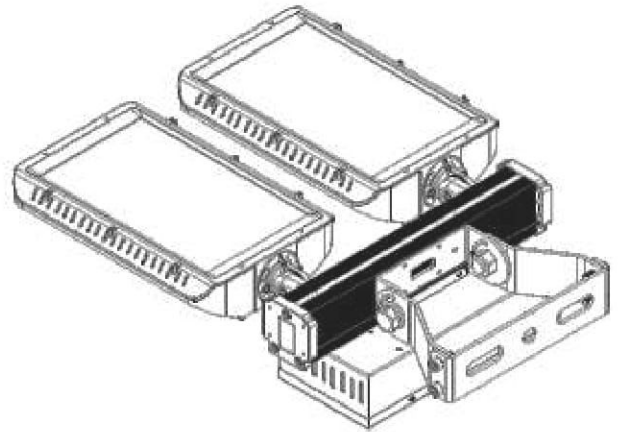
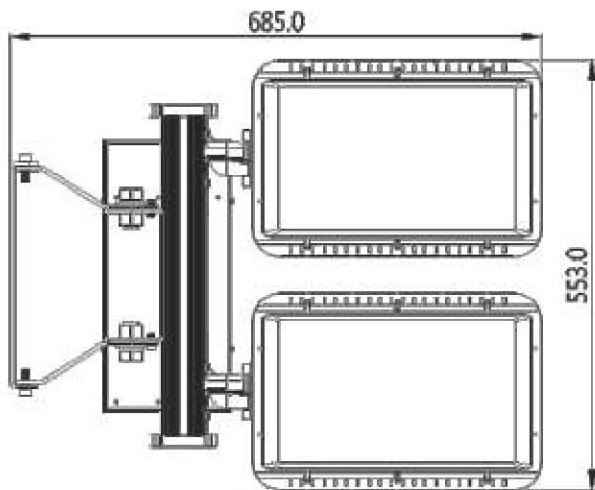

# BEAM ANGLE

DRAGONFLY LED Sports Floodlighting 480W 600W

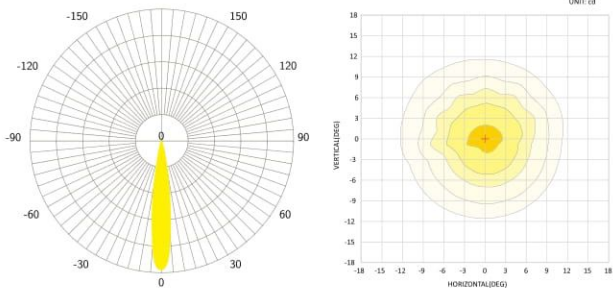

10°

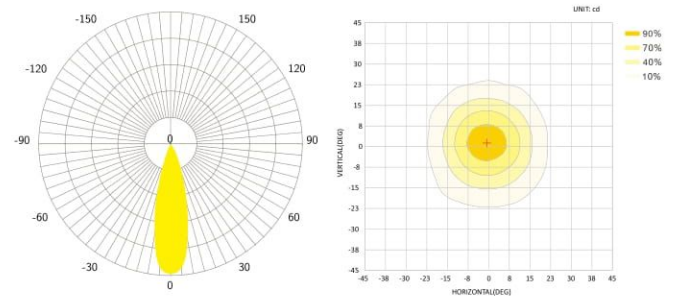

20°

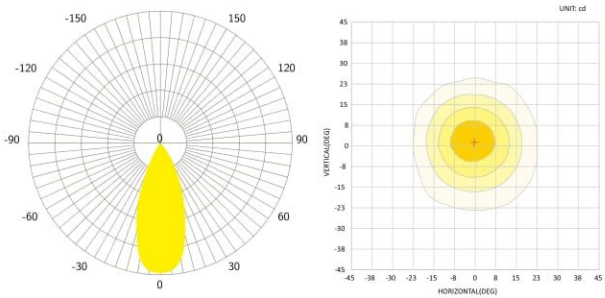

40°

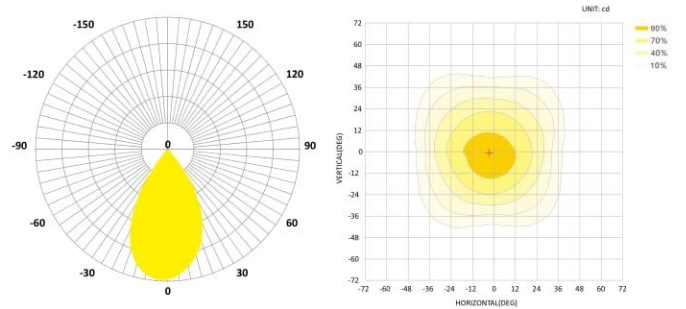

60°

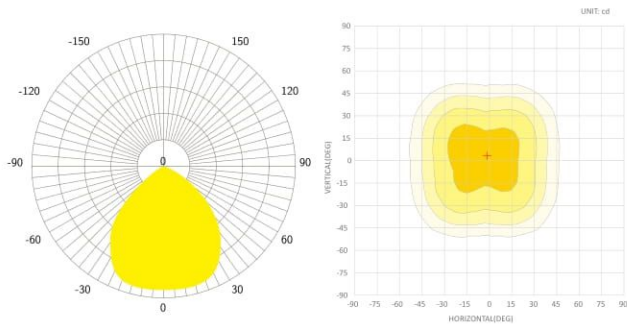

90°

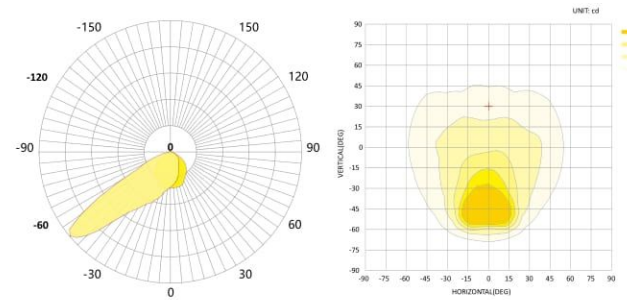

97\*47°(TypeIV)

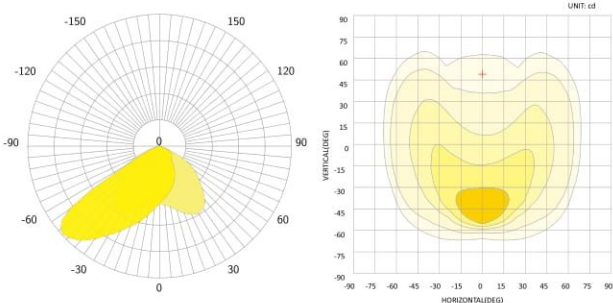

P50

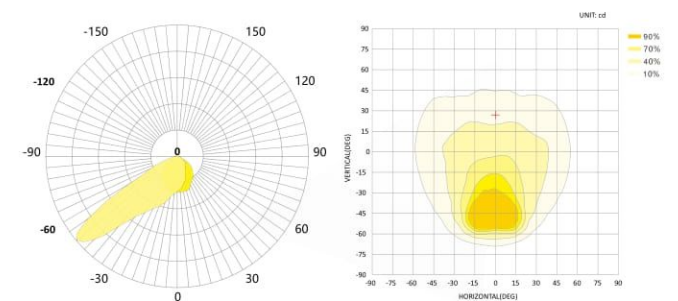

P50-P8

# ACCESSORY

DRAGONFLY LED Sports Floodlighting 480W 600W

---

## ► Options

---



### ▲ IRON bracket

The bracket is optional to use by iron materials



### ▲ Anti-glare cover

Black color and white color are optional  
(the reflective rate of white color will be better)



### ▲ Anti-glare cover

Black color and white color are optional  
(the reflective rate of white color will be better)



### ▲ Meanwell HLG driver

It's optional with Meanwell HLG driver



### ▲ SPD

Optional with 10KV or 20KV SPD