

ME81AH Heating Thermostat Manual

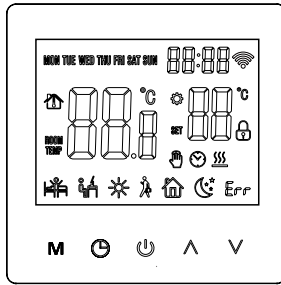

Application

The thermostat is designed for control of electric heating devices (Built in sensors for measuring room temperature and external sensor for high temperature protection , to prevent heating device burned due to high temperature).

User Operation

- ON/OFF** Power Key : Touch the On / Off key to turn the system on or off.
- M** Mode Key :You can select “period control mode” or “manual mode” by this key.
- UP/DOWN** Up / Down key: Touch the Up and Down keys to set the temperature and adjust system parameters. And press Up and Down simultaneously and hold for 5 seconds to enter lock key function.
- CLOCK** Clock key: You can adjust the time and the week by this key.
- MANUAL** Manual mode: Set the temperature manually by this key.
- WEEK** Automatic mode: Adjust to the automatic mode, the thermostat will work cyclically by week programming.

Anti-frozen function

In the state of shutdown, the thermostat will turn on the heating device automatically When the room temperature is below 5°C. when the room temperature is above 7°C, the thermostat will turn off the heating device automatically.

Technical data

1. Temperature sensor : NTC
2. Temperature accuracy : ±1°C
3. Power consumption : <1W
4. Voltage: AC230V 50/60Hz

5. Load current : 3A/16A
6. Temperature setting : 5~90°C
7. Key : Touch key

Programming: 6 –event time and temperature

In the shutdown state, long press mode key " M " and the clock key " ⌚ " for 5 seconds to enter programming mode. you can switch parameters by mode key. After entering the programming mode , press mode key to adjust " hour" ,then press mode key to adjust "minute".Press the mode key again to adjust temperature.

- 1 .Wake-up
- 2 .Leave
- 3 Return(am)
- 4.Leave(pm)
- 5.Return(pm)
- 6.Sleep

Key	Event	Symbol	Time	^ V	Default value	^ V
M	Week day	01	06:00	Set time	20°C	Set temperature
		02	08:00		15°C	
		03	11:30		15°C	
		04	12:30		15°C	
		05	17:00		22°C	
		06	22:00		15°C	
M	Weekend	01	08:00	Set time	22°C	Set temperature
		02	23:00		15°C	

Advanced setting (qualified person preferred)

Press" M "and" V "at the same time to enter the mode of advanced setting immediately when thermostat is turned off. The following seven functions can be chosen by" M "key.

Symbol	Setting	Default value	^ or V
1	ADJ Temperature calibration	-2	Adjust measured temperature range:-9~9°C
2	SEN Sensor mode	IN	IN:built-in sensor OU:floor sensor AL:both sensor
3	OPR Overheating protection	60°C	Adjust range:5°C~60°C
4	DDI Switching differential	1°C	Adjust switching differential range:1-5°C
5	SLP Anti-frozen function	ON	Turn on(01)/off(00) Anti-frozen function
6	PER Kinds of periods of time mode	01	OF : Close 01:5+2 day mode 02:6+1 day mode 03:7 +0day mode
7	WFL Max . temperature	40	Adjust range:30°C~90°C
8	LLL Set the lower limit of temperature	10	Adjust range:5°C~20°C
9	REC Reset to factory settings	=	Press" A "and hold for 5s, all parameters will be reset

Mounting steps

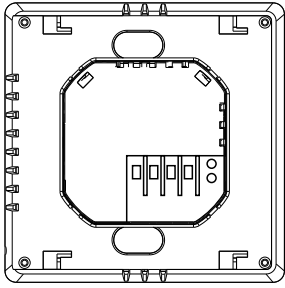

1. Connect the power supply box according to the wiring diagram.

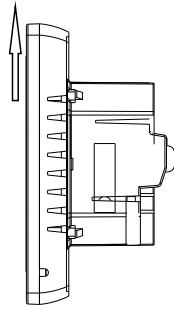

2. Push the panel up and take down the panel.

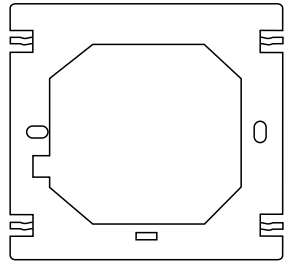

3. Install the fixed plate of thermostat in electrical connection box with screws.

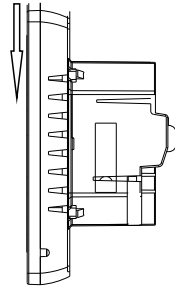

4. Make the panel buckle to the fixed plate and push it down.

Mounting Location Recommended

The heating thermostat should be mounted on the wall with air flowing freely around.
Warning: The mounting location should not be influenced by other heat source (e.g. sunlight), air flow through doors & windows or temperature of outer wall.

Common failure handling

Failure	Handling
Crash	1. Check the power supply wiring is correct or not. 2. Check the power key.
LCD display garbled	1. The shell is deformed after installation, can be reinstalled.
Display normal No output	1. Check whether the wiring between the MPU and the power board is damaged. 2. Check whether the null line of live line is connected wrong.
Remote failure	Check if the remote control battery has enough power, if not replace the battery.
Temperature display error	Adjust the panel temperature display by the first option in the Advanced tab.
Sensor failure	Check the sensor for damage Er1: Built-in sensor disconnected or fault with it. Er2: External sensor disconnected or fault with it.

Wiring diagram

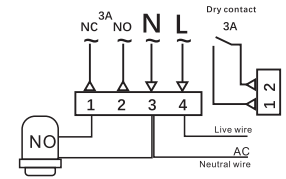
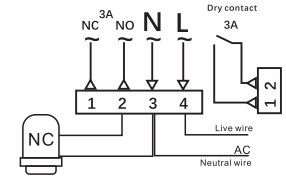
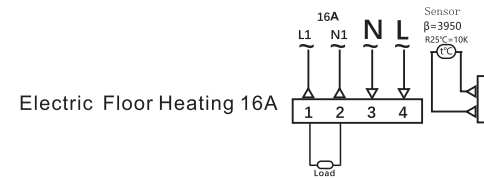
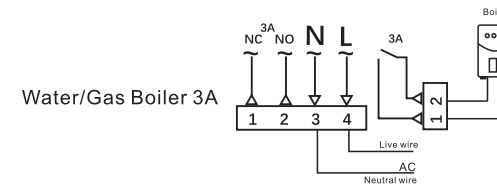

Icon description :

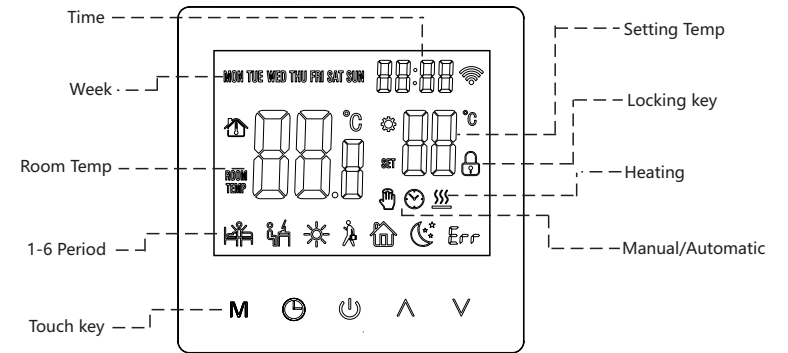

Dimension

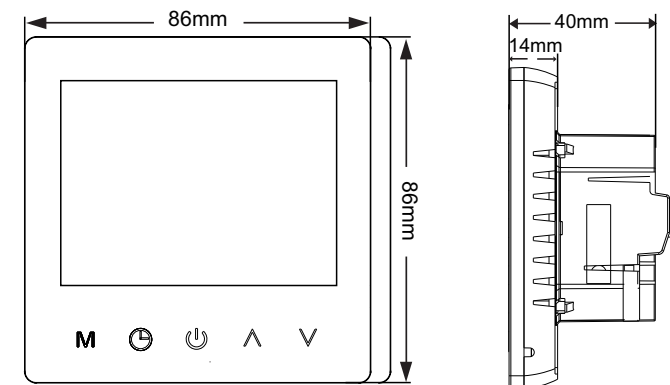

1)Thermostat networking steps:

Press and hold the up and down keys for about 5 seconds when the thermostat is turned off . When you hear the buzzer ringing 3 sounds, the thermostat enters the distribution network interface. After the screen displays full display(or press the power button to exit)the thermostat has entered the network initialization status .When the WiFi symbol "📶" of the thermostat does not flash, it indicates that the connection is successful. Please note that the router or the corresponding WiFi device is turned on and within 5 meters of the thermostat.

2)Mobile phone networking steps:

Before configuring WIFI , please make sure your phone is connected to 2.4GHz WIFI.

1. Use your mobile phone to scan the QR code below to download the " Tuya Smart " app.

China



2.Open the "Tuya Smart " app and click "Add Device " as shown below.

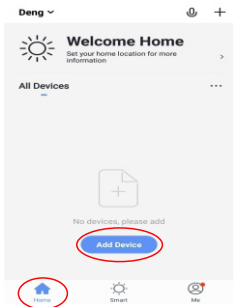

4.Click" confirm indicator rapidly blink" as shown below.

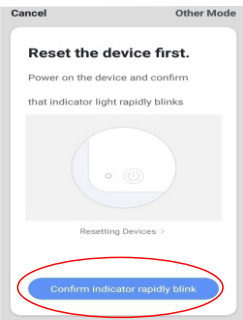

Foreign



3.After clicking" Small Home Appliances" , select "Thermostat" as shown below.

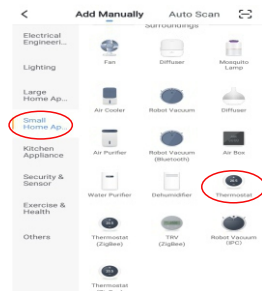

5.After entering the WIFI password, press" Confirm" as shown below.

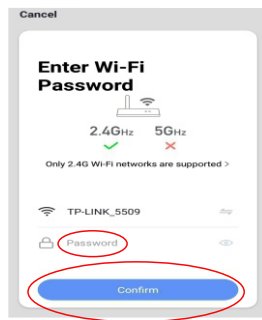

6.The phone enters the device search and the connection mode is as shown below.

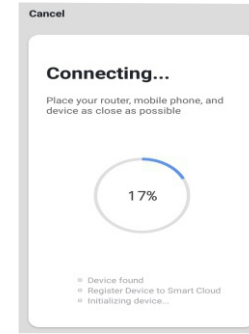

7.The mobile phone adds the device connection successfully, click" Done" as shown below.

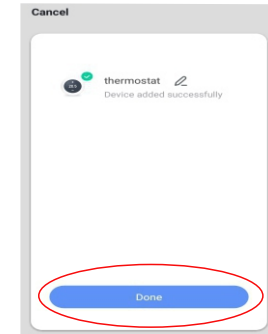

8.Click on the" Done" button above to enter the control interface as shown below.

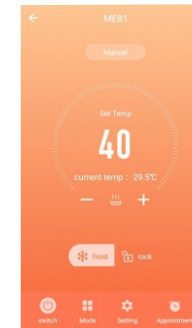

3)Device sharing instructions:

1.Click" Share Device" as shown below.

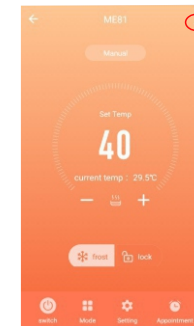

2.Click" Share Device" as shown below.

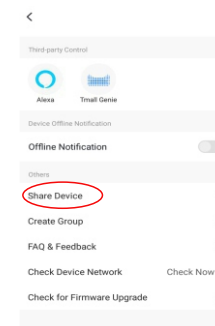

3.Click" Add Sharing" as shown below.

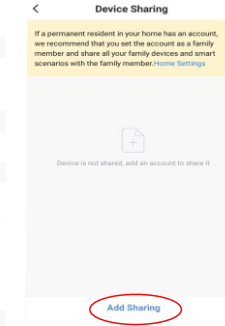

4.After entering the account number ,click" Done" as shown below.

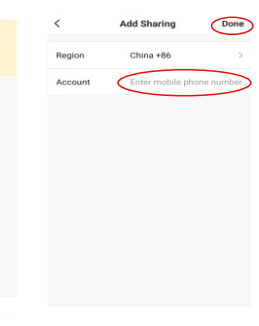

4)Thermostat and mobile phone Exit the network:

Press and hold the up and down button for about 5 seconds while the thermostat is off. When the buzzer sounds 3 times into the distribution network interface, the screen displays full display. At this time (or press the power button to exit) the control panel has entered the network exit state (also the distribution network state).